

heatmiser®



Model: **DT-B**



Table of Contents

Product Image	1
Table of Contents	2
What is a Room Thermostat?	3-4
Installation Procedure	5-6
Installing the Batteries	7-9
Replacing the Batteries	10
LCD Display	11-12
Temperature Display	13
Locking the Thermostat	14
Temperature Control	15
Power ON / OFF	15
Frost Protection	16
Optional Features	17-19
Re-calibrating the Thermostat	20
Factory Reset	20
Wiring Diagrams	21-22



What is a Room Thermostat?

A room thermostat simply switches the heating system on and off as necessary.

It works by sensing the air temperature, switching on the heating when the air temperature falls below the thermostat setting, and switching it off once this set temperature has been reached.

Setting a room thermostat to a higher temperature will not make the room heat up any faster. How quickly the room heats up depends on the design and size of the heating system.

Similarly reducing the temperature setting does not affect how quickly the room cools down. Setting a room thermostat to a lower temperature will result in the room being controlled at a lower temperature and saves energy.

The way to set and use your room thermostat is to find the lowest temperature settings that you are comfortable with, and then leave it alone to do its job.

The best way to do this is to set the room thermostat to a low temperature – say 18°C, and then turn it up by 1°C each day until you are comfortable with the temperature. You won't have to adjust the thermostat further. Any adjustment above this setting will waste energy and cost you more money.

If your heating system is a boiler with radiators, there will usually be only one room thermostat to control the whole house. But you can have different temperatures in individual rooms by installing thermostatic radiator valves (TRVs) on individual radiators.

If you don't have TRVs, you should choose a temperature that is reasonable for the whole house. If you do have TRVs, you can choose a slightly higher setting to make sure that even the coldest room is comfortable, then prevent any overheating in other rooms by adjusting the TRVs.

Room thermostats need a free flow of air to sense the temperature, so they must not be covered by curtains or blocked by furniture. Nearby electric fires, televisions, wall or table lamps may also prevent the thermostat from working properly.



Installation Procedure



Do
Mount the thermostat at eye level.
Read the instructions fully so you get the best from our product.



Don't
Do not install near to a direct heat source as this will affect functionality.
Do not push hard on the LCD screen as this may cause irreparable damage.

This battery thermostat is designed to be surface mounted.

Step 1

Carefully separate the front half of the thermostat from the back plate by placing a small flat head terminal driver into the slots on the bottom face of the thermostat.

Step 2

Mark 2 hole positions on the wall using the back plate as a positioning template. Drill the marked positions and insert a wall plug into each hole. Terminate the thermostat as shown in the diagrams on pages 21-22 of this booklet.

Step 3

Screw the thermostat back plate securely on the wall and fit the terminal cover.

Step 4

Clip the front of the thermostat back onto the thermostat back plate.

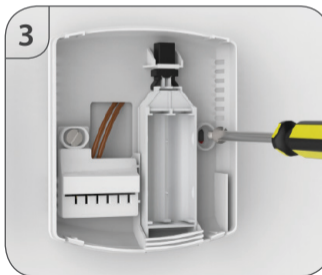
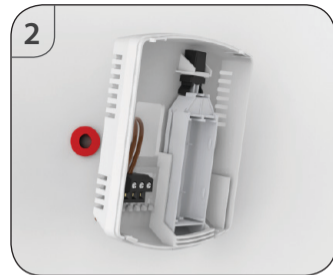



Installing the Batteries

2x AAA batteries have been supplied with this thermostat.

To access the battery holder, push and release the compartment door located on the bottom face of the thermostat.



Insert the batteries in the empty battery holder, ensuring that each battery is orientated for the correct polarity + / - .



Push the battery holder back inside the thermostat until it is secured in its closed position.



Replacing the Batteries

Batteries have a fixed lifespan and will need to be replaced occasionally to ensure the thermostat operates correctly.

The thermostat will inform you when the batteries need to be replaced by displaying the battery icon on screen.

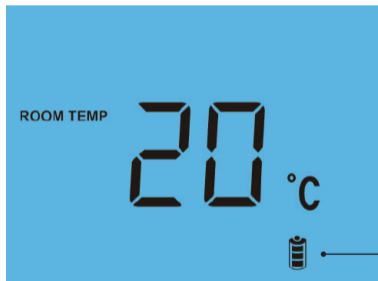

Battery Icon
(Flashes)

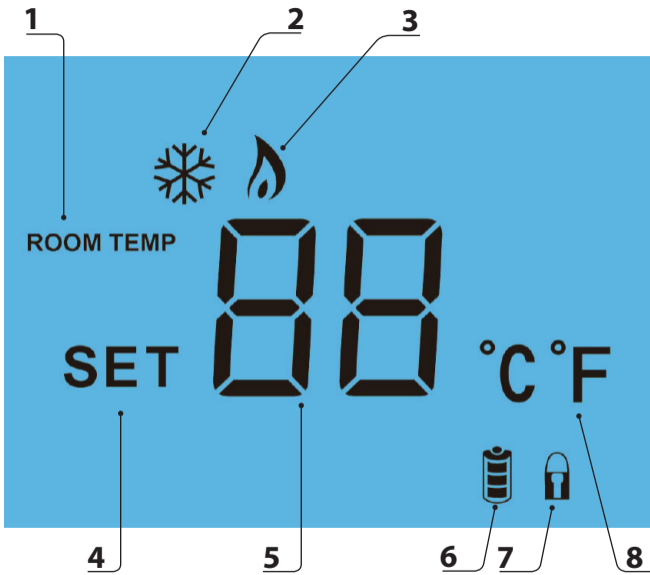

LCD LCD Display

1. Room Temp - Indicates the current temperature sensor mode.
2. Frost Icon - Displayed when the thermostat is in frost protection mode.
3. Flame Icon - Displayed when the thermostat is calling for heat.
4. Set - Displayed when the target temperature is adjusted.
5. Current Temp - Indicates the current sensor temperature.
6. Battery Level - Indicates when the batteries require replacement.
7. Keypad Lock Indicator - Displayed when the keypad is locked.
8. Units of Temperature - Degrees Celsius or Fahrenheit.



Temperature Display

The temperature display information is driven by two different inputs; the sensor measurement and the target temperature you have set.

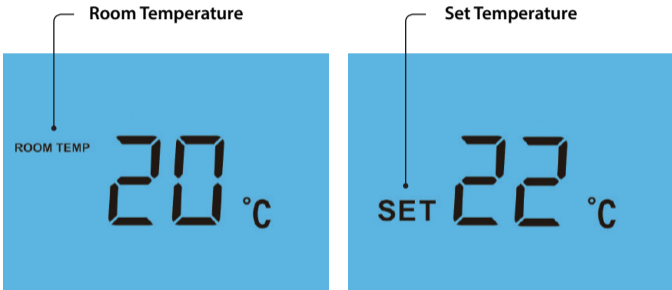



This is the current room temperature.

This is the temperature you are trying to achieve in your home.



Locking the Thermostat

The thermostat has a keypad lock facility. To activate the lock follow these steps.

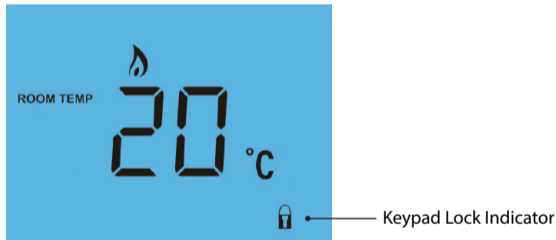

- Press and hold the A and Down keys together for 10 seconds 
- You will see the lock symbol appear on screen 
- To unlock, repeat the steps above until the lock symbol disappears.





The keypad lock indicator is only visible when the lock is active.



Temperature Control

The Up/Down keys allow you to adjust the set temperature  

When you press either of these keys, you will see the word SET and the desired temperature will be displayed on screen.

Use the Up/Down keys to modify the SET value  

Press A to confirm settings and return to main display 



Heating On/Off

The heating is indicated ON when the flame icon is displayed.

When the flame icon is absent, there is no requirement for heating to achieve the set temperature but the thermostat remains active.

To turn the thermostat OFF completely, press and hold the Power button 

The display and heating output will be turned OFF completely.*

To turn the thermostat back ON, press the Power button once 

*See Feature 3 on page 17



Frost Mode

Pressing the  button once will place the thermostat in frost protect mode.

In this mode, the thermostat will display the frost icon and will only turn the heating on should the room temperature drop below the set frost temperature (see page 17).

Should the heating be turned on whilst in frost mode, the flame symbol will be displayed.

To cancel the frost protect mode, press the  button once.

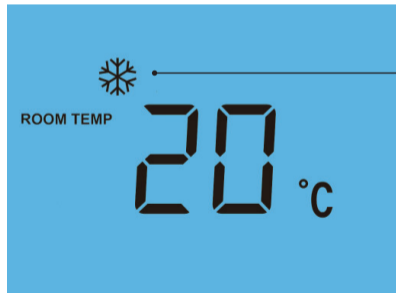



Optional Features Explained

THE FOLLOWING SETTINGS ARE OPTIONAL AND IN MOST CASES NEED NOT BE ADJUSTED

Feature 01 - Temperature Format: This function allows you to select between °C and °F.

Feature 02 – Switching Differential: This function allows you to increase the switching differential of the thermostat. The default is 1°C which means that with a set temperature of 20°C, the thermostat will switch the heating on at 19°C and off at 20°C. With a 2°C differential, the heating will switch on at 18°C and off at 20°C.

Feature 03 – Frost Protect: You can set whether the thermostat will maintain the frost temperature when the thermostat display is turned off. As a default, this is enabled.

Feature 04 – Frost Protect Temperature: This is the temperature maintained when the thermostat is in frost mode. The range is 07 - 17°C. The default is 12°C and is suitable for most applications.



Feature 05 – Output Delay: To prevent rapid switching, an output delay can be entered. This can be set from 00-15 minutes. The default is 00 which means there is no delay.

Feature 06 – Temperature Up/Down Limit: This function allows you to limit the use of the Up and Down keys. This limit is also applicable when the thermostat is locked and so allows you to give others limited control over the heating system.





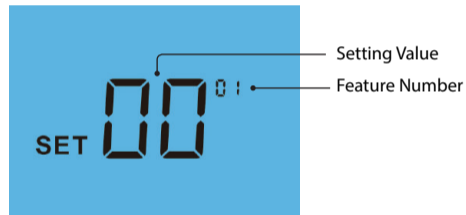

Adjusting the Optional Settings

To adjust the optional settings, follow these steps.

- Press and hold the Power button to turn the thermostat OFF 
- Press and hold the Clock key until the display appears as below 



- Use the Clock key to cycle through the features 
- Use the Up/Down keys to change the setting 
- Press A to confirm settings 
- Press the Power button once to turn the thermostat back ON 







Optional Settings - Feature Table

FEATURE	DESCRIPTION	SETTING
01	Temperature Format	00 = °C 01 = °F (°C = Default)
02	Switching Differential	01° - 03°C (01°C = Default)
03	Frost Mode	00 = Enabled 01 = Disabled (00 = Default)
04	Frost Protection Temperature	07° - 17°C (12°C = Default)
05	Output Delay	00 - 15 Minutes (00 = Default)
06	Up/Down Temperature Limit	00° - 10°C (00°C = Default)



Re-calibrating the Thermostat

If you need to re-calibrate the thermostat, follow these steps.



- Press and hold the Power button to turn the thermostat OFF 
- Press and hold BOTH the Power and Down keys together until the temperature appears on the screen 
- Use the Up/Down keys to configure the new temperature 
- Press A to confirm settings 
- Press the Power button once to turn the thermostat back ON 



Factory Reset

The thermostat has a reset function to restore all settings to their factory defaults.

To perform a factory reset, follow these steps.

- Press and hold the Power button to turn the thermostat OFF 
- Press and hold both the Power and Up keys together until the LCD powers up. All of the icons will be displayed on screen 
- When the icons have disappeared from the screen, the thermostat has been successfully reset.
- Press the Power button once to turn the thermostat back ON 



Wiring Diagram - DT-B Switched Live & Valve Systems

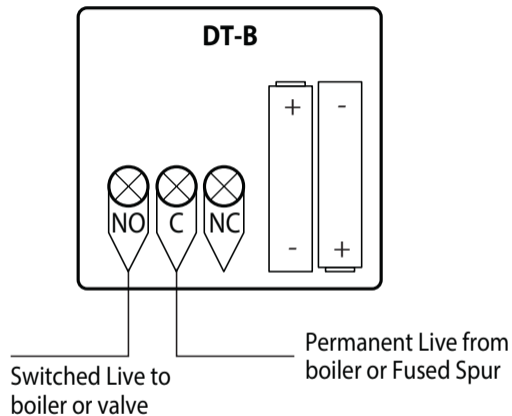

Note: When connecting to a valve, the valve auxiliary switch is used to enable the boiler.



Wiring Diagram - DT-B Voltagefree & Combi Boiler Systems

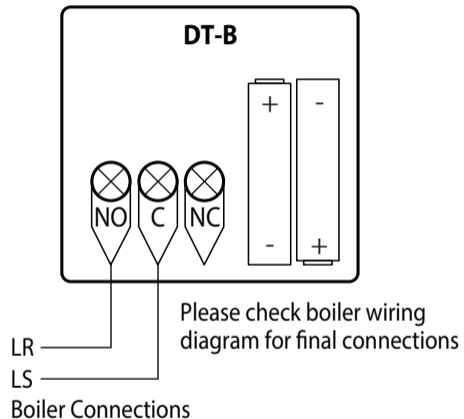

Note: LS & LR may be labelled differently but they are normally the boiler's room thermostat connections.



Heating Professionals:
Request a copy of our product installation guide containing detailed technical specifications for our complete product range:
www.heatmiser.com/guide

Want More Information?

Call our support team on: +44 (0)1254 669090

Or view technical specifications directly on our website:
www.heatmiser.com



PDF



FAQ



Twitter: [heatmiseruk](https://twitter.com/heatmiseruk)



Facebook: facebook.com/thermostats